

SPECIFICATION

MODEL	MA-20G13(S)		
FREQUENCY	50 Hz	60 Hz	
RATED LOAD	1500 kg	1500 kg	
ROPE SPEED	13 m/min	16 m/min	
LENGTH OF WINDING	ø16×180m		
MOTOR	OUTPUT	POLES	VOLTAGE
	3.9kW	4P	200V
ISO CLASS	M5		
WEIGHT	600 kg		

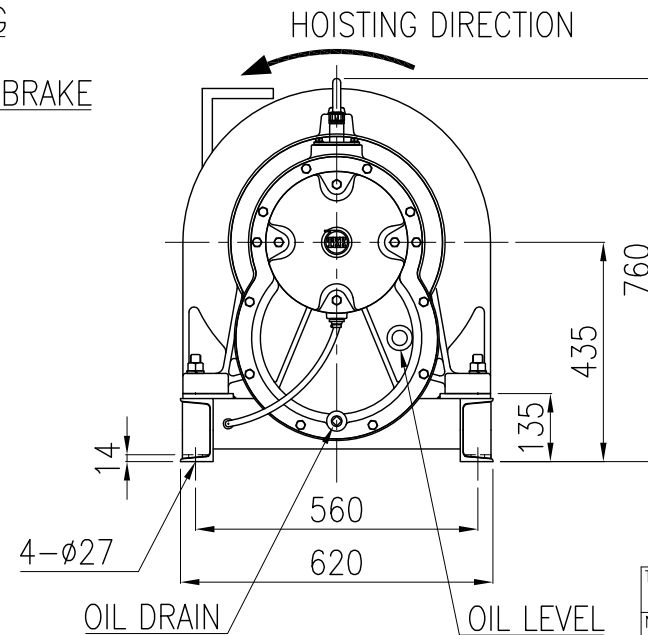
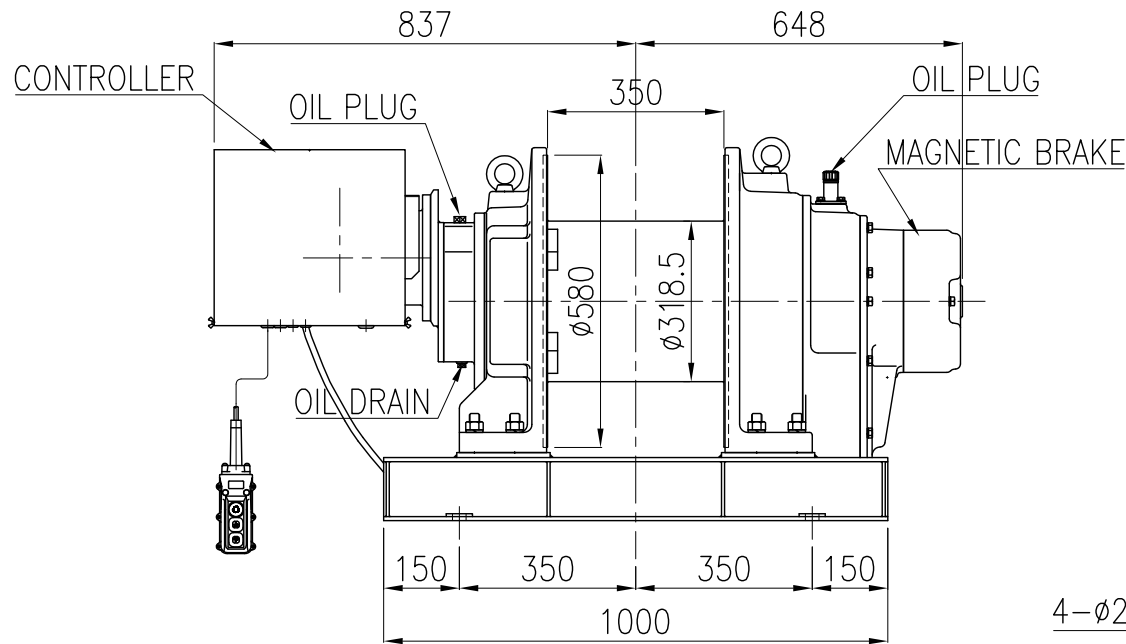

TYPE	MA-20G13(S)
NAME	OUTLINE
DRAWN No.	051466