

SPECIFICATION

MODEL	MA-7G17(S)		
FREQUENCY	50 Hz	60 Hz	
RATED LOAD	1000 kg	850 kg	
ROPE SPEED	17 m/min	20 m/min	
LENGTH OF WINDING	ø12×150m (7Ls)		
MOTOR	OUTPUT	POLES	VOLTAGE
	3.9kW	4P	200V
ISO CLASS	M5		
WEIGHT	350 kg		

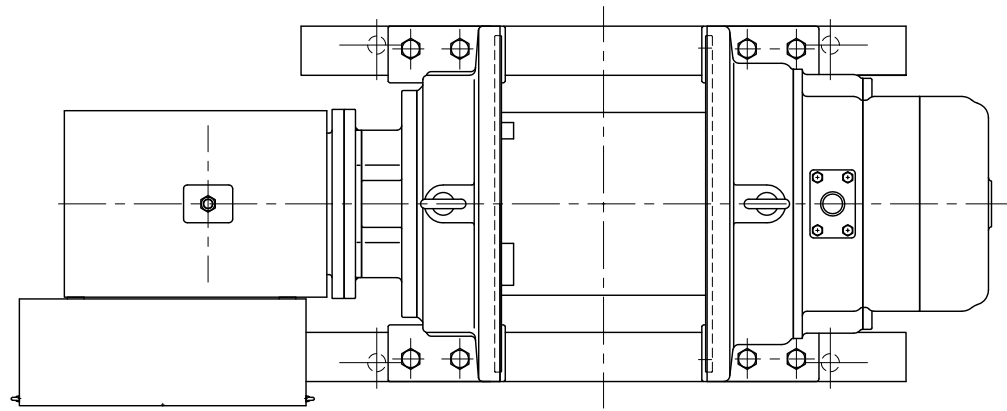

CONTROLLER

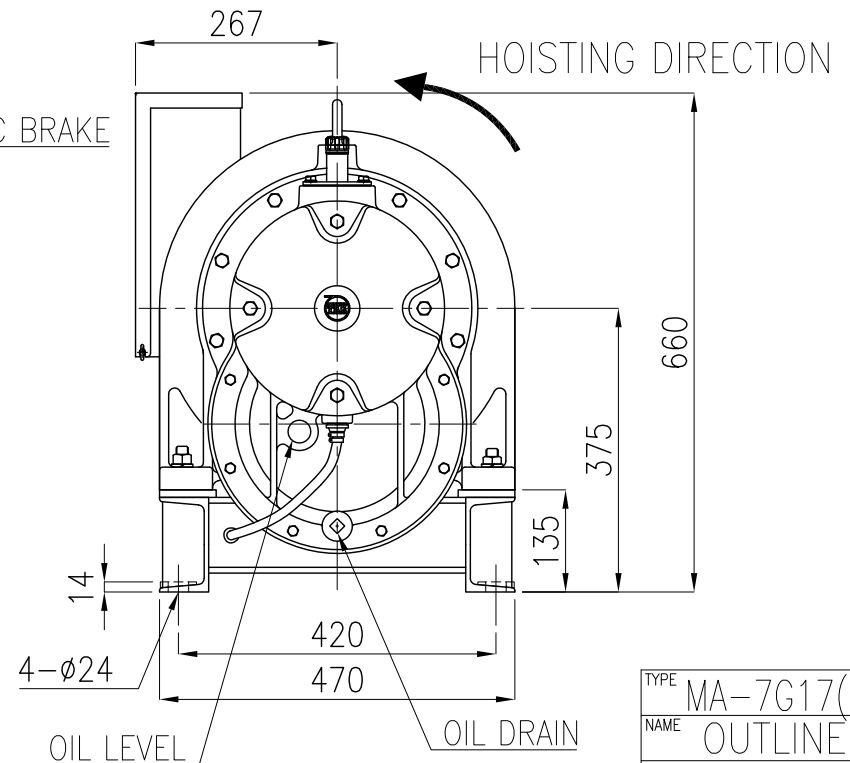
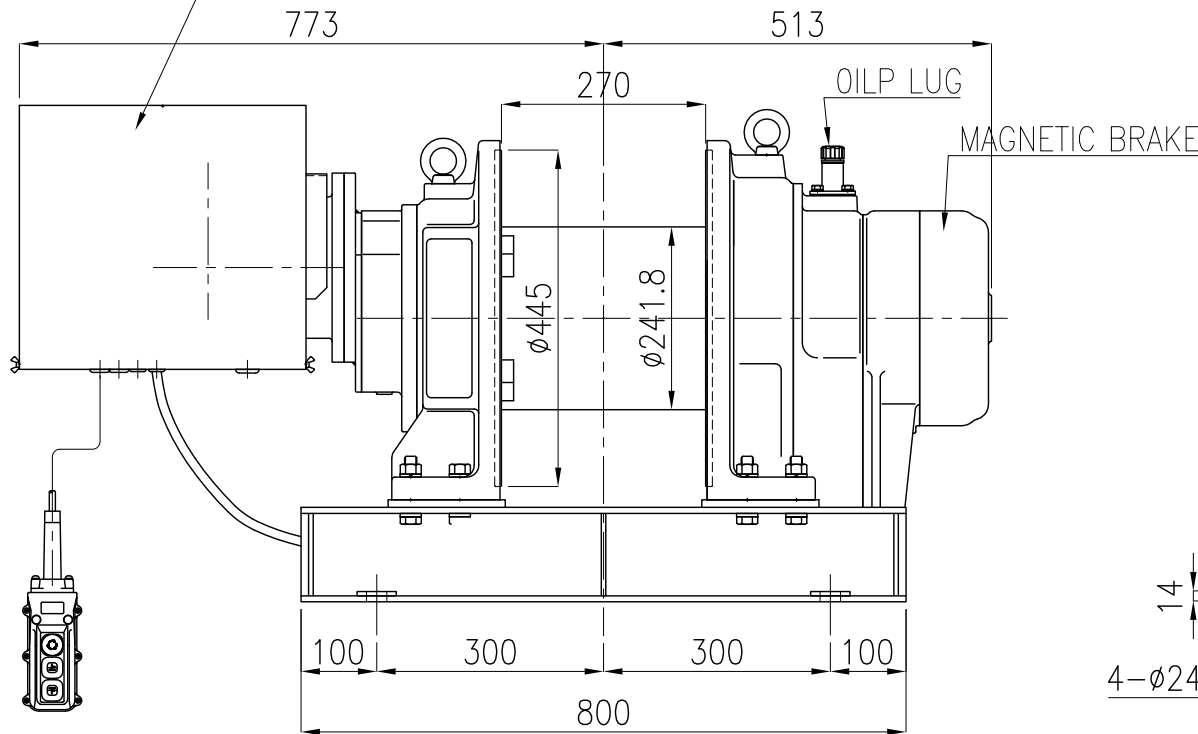

TYPE	MA-7G17(S)
NAME	OUTLINE
DRAWN No.	051463