

SPECIFICATION

MODEL	MA-3G10(S)		
FREQUENCY	50 Hz	60 Hz	
RATED LOAD	400 kg	400 kg	
ROPE SPEED	10 m/min	12 m/min	
LENGTH OF WINDING	ø8×120m (8Ls)		
MOTOR	OUTPUT	POLES	VOLTAGE
	0.87kW	4P	200V
ISO CLASS	M5		
WEIGHT	175 kg		

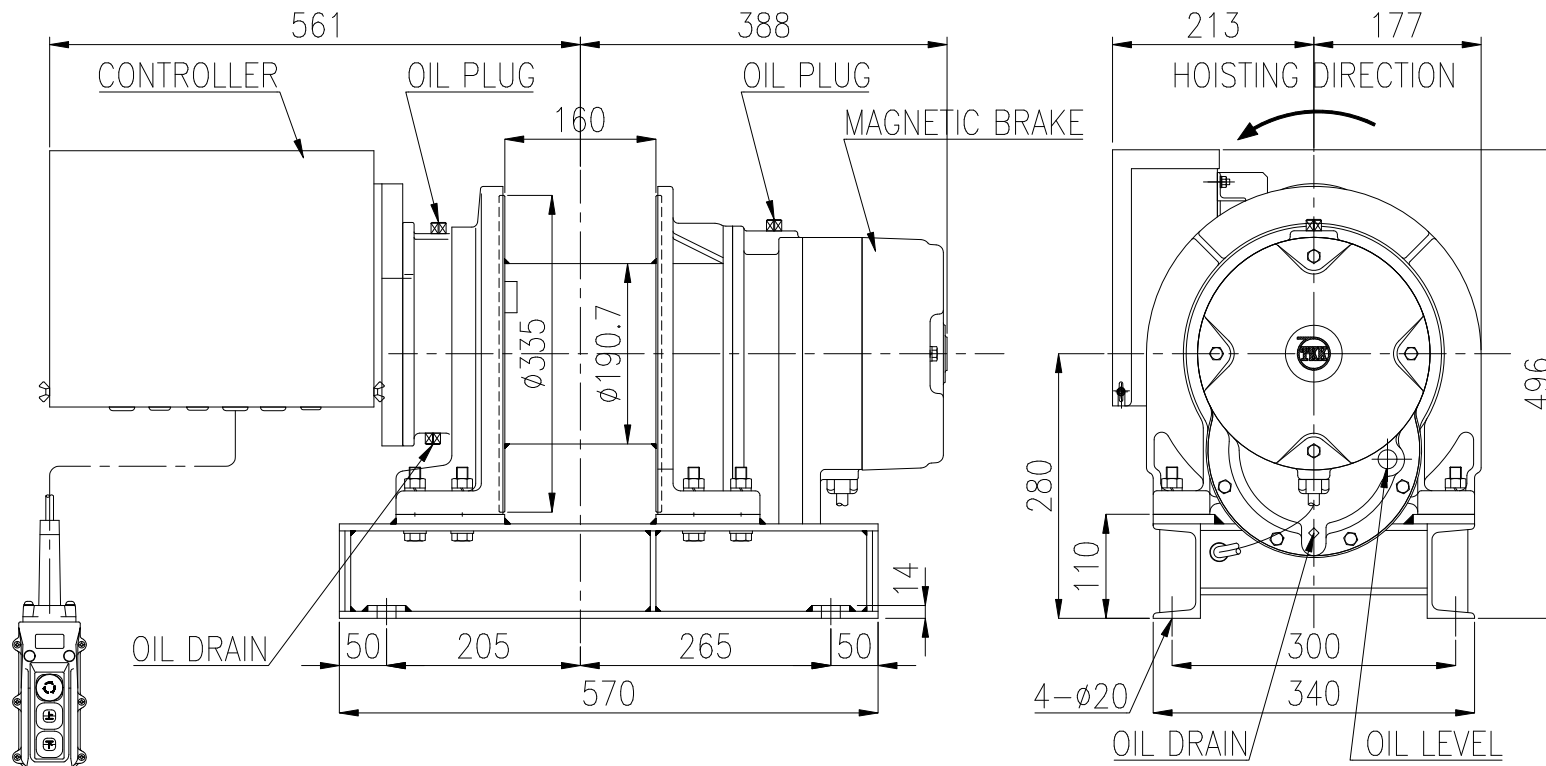
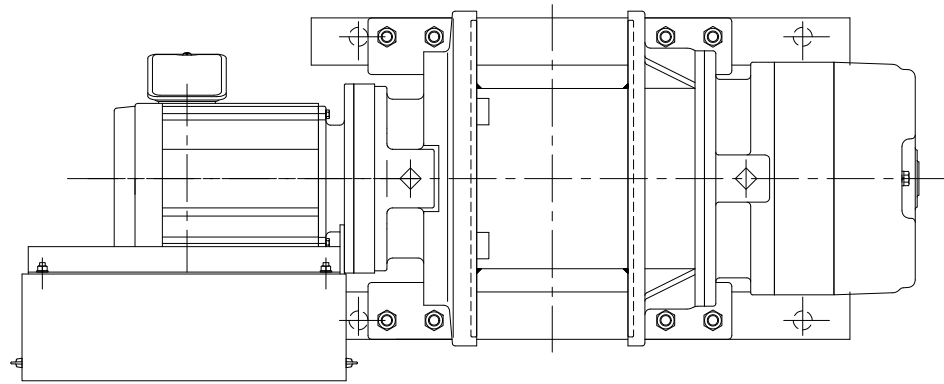

TYPE	MA-3G10(S)
NAME	OUTLINE
DRAWN No.	052438